

Français - phonologie

Compte et colorie le bon nombre de syllabes.

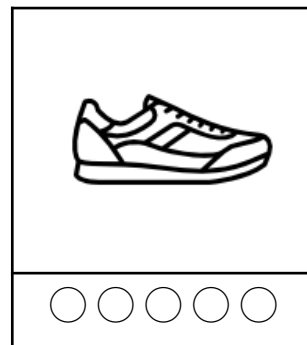
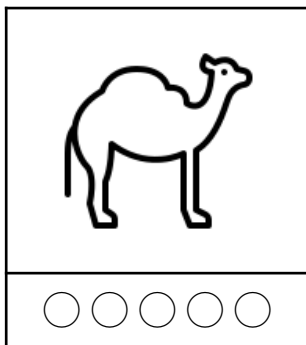
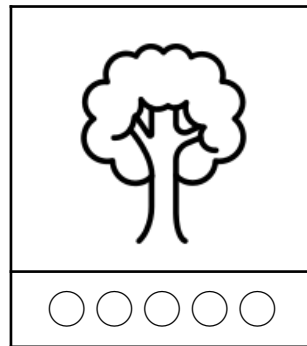
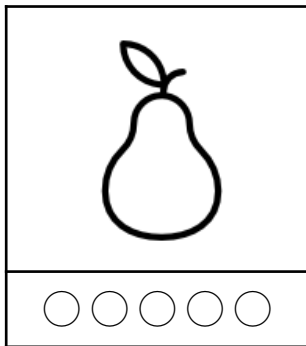
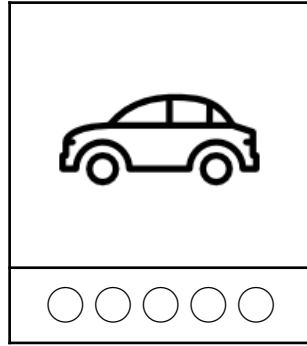
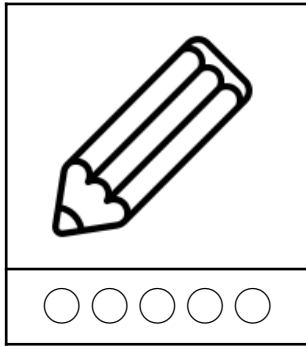

Français - phonologie

Compte et colorie le bon nombre de syllabes.

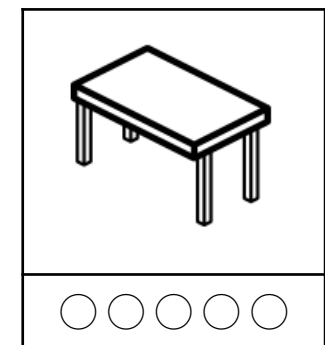
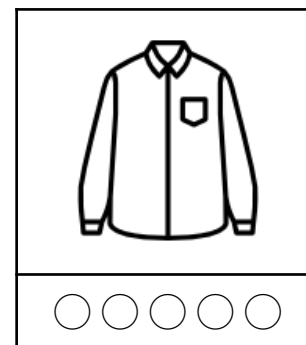
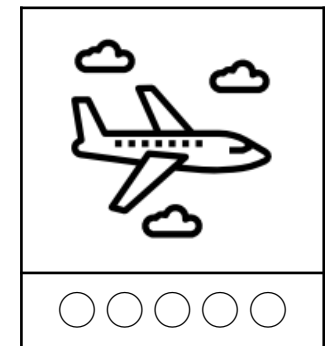
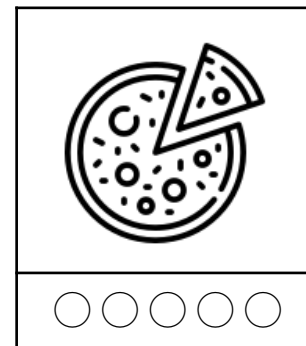
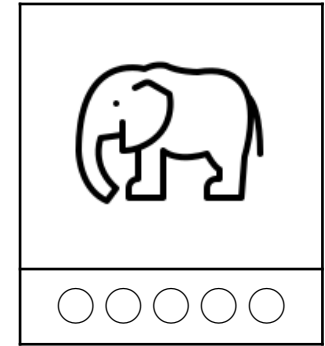
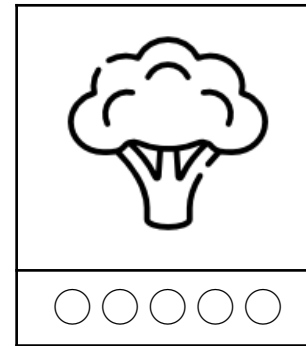

Français - phonologie

Compte et colorie le bon nombre de syllabes.



○ ○ ○ ○ ○



○ ○ ○ ○ ○



○ ○ ○ ○ ○



○ ○ ○ ○ ○



○ ○ ○ ○ ○



○ ○ ○ ○ ○

Français - phonologie

Compte et colorie le bon nombre de syllabes.



○ ○ ○ ○ ○



○ ○ ○ ○ ○



○ ○ ○ ○ ○



○ ○ ○ ○ ○



○ ○ ○ ○ ○



○ ○ ○ ○ ○

Français - phonologie

Compte et colorie le bon nombre de syllabes.

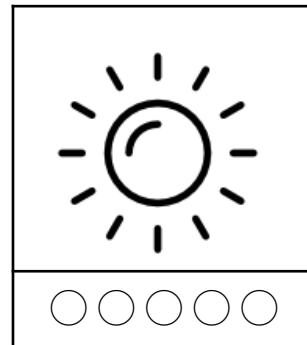
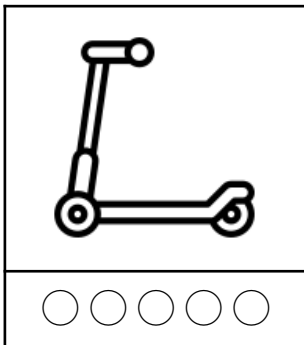
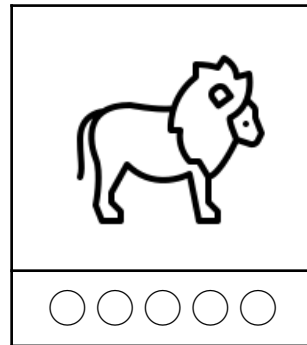
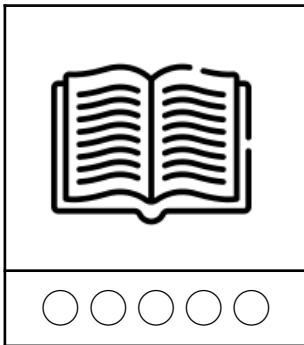
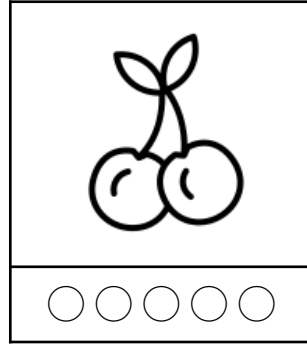
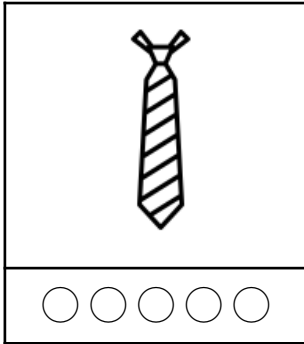

Français - phonologie

Compte et colorie le bon nombre de syllabes.

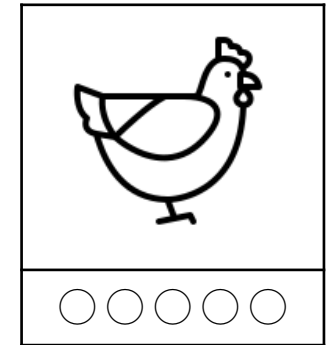
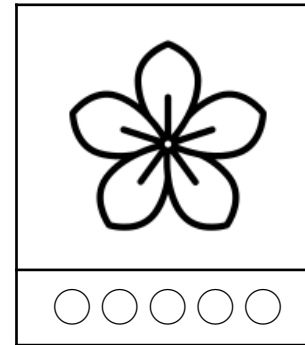
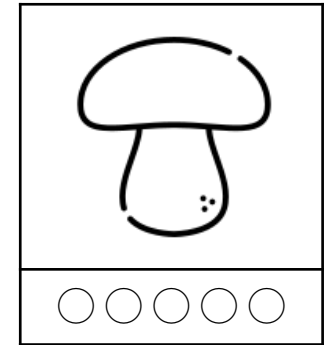
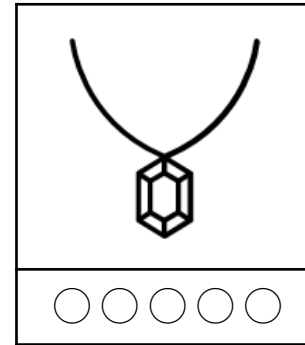
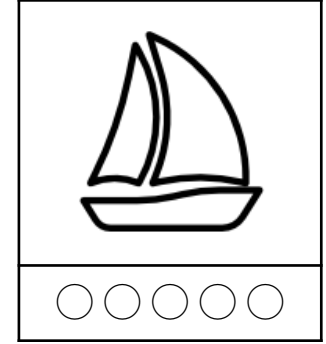
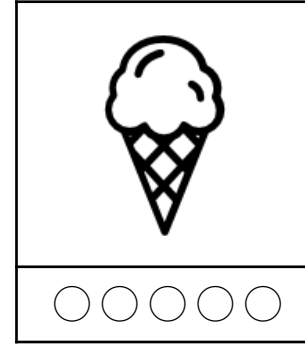

Français - phonologie

Compte et colorie le bon nombre de syllabes.

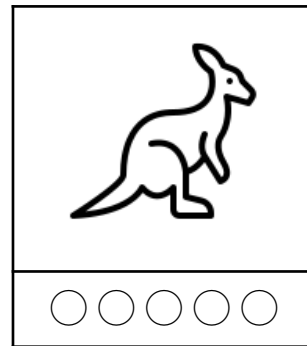
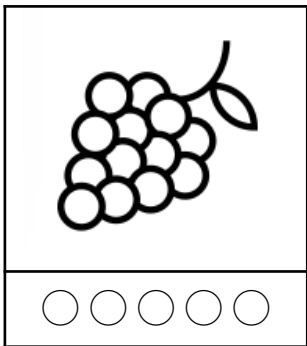
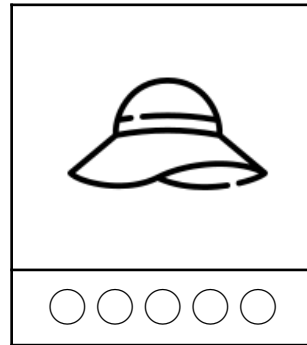
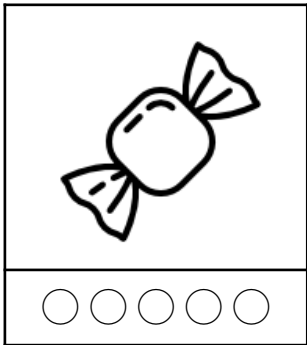
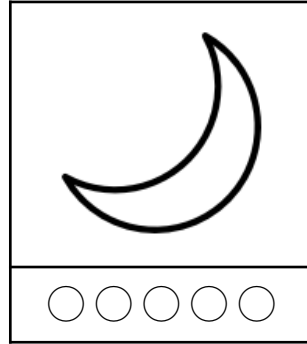
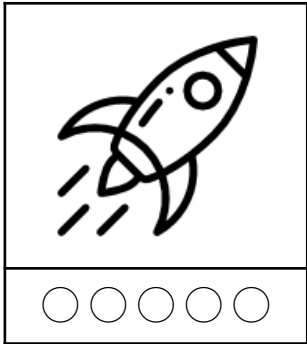

Français - phonologie

Compte et colorie le bon nombre de syllabes.

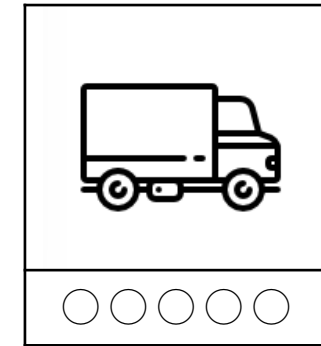
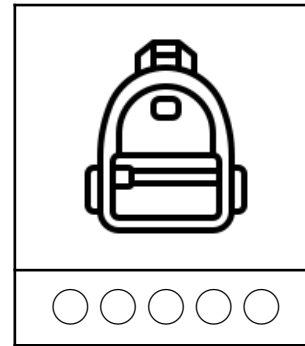
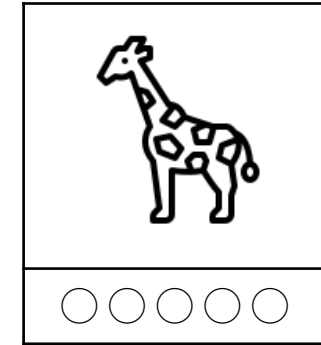
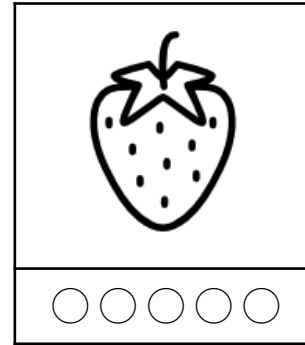
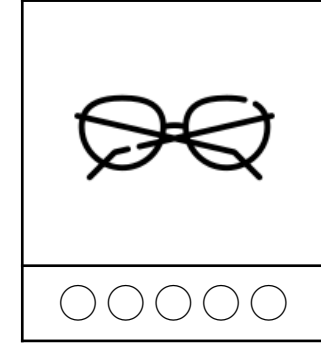

Français - phonologie

Compte et colorie le bon nombre de syllabes.

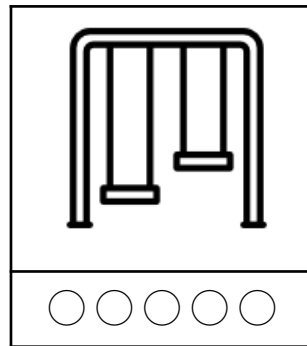
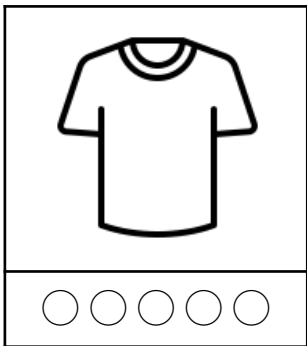
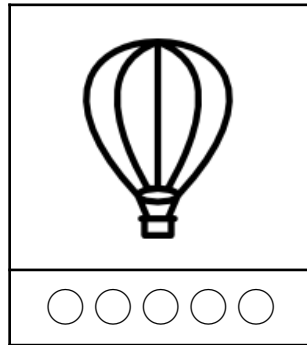
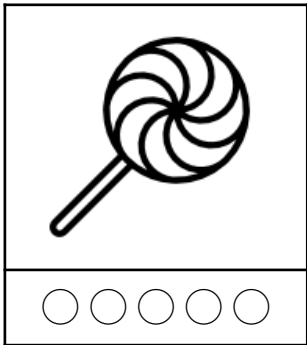
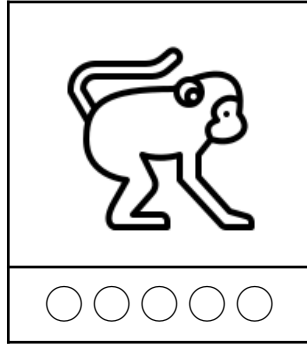
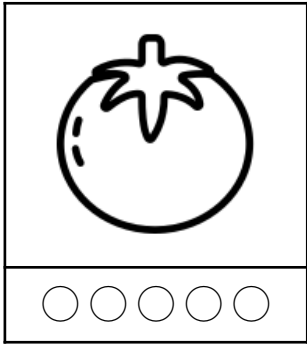

Français - phonologie

Compte et colorie le bon nombre de syllabes.

